

DEKO 190GT WASHER DISINFECTOR

**rhima**

OPERATORS MANUAL



Rhima Australia  
WASHING EQUIPMENT  
Tel: 03 8586 5444  
[www.rhima.com.au](http://www.rhima.com.au)



## TABLE OF CONTENTS

1	SAFETY INSTRUCTIONS AND WARNINGS.....	4
2	INTENDED USE OF THE MACHINE .....	5
3	STORAGE CONDITIONS .....	7
4	OPERATING CONDITIONS.....	7
5	OPERATING INSTRUCTIONS .....	8
5.1	Washing and disinfection cycles.....	8
5.1.1	Standard cycles / 190.....	8
5.1.2	Standard cycles / 190 (AU,NZ).....	9
5.1.3	Sequence diagrams.....	10
5.2	Values of the cycles .....	11
5.3	Process chemicals .....	11
5.4	Requirements on detergent in Deko washer-disinfectors .....	12
5.5	Process variables.....	13
5.6	Required conditions .....	13
5.7	Controls.....	14
5.7.1	Operating systems, manual door.....	14
5.7.2	Running a cycle .....	15
5.7.3	Malfunctions.....	20
5.8	Purging and disinfecting the WD.....	22
5.9	Methods of cleaning.....	22
5.10	Flushing of chemical dosing systems.....	22
6	TESTING .....	23
7	RECYCLING AND DISPOSAL INSTRUCTIONS.....	23
8	DECLARATION OF CONFORMITY .....	24
9	WARRANTY TERMS AND CONDITIONS.....	25
APPENDICES		
APPENDIX 1	LIST OF MALFUNCTIONS .....	27
APPENDIX 2	USER INSTRUCTIONS .....	31

## 1 SAFETY INSTRUCTIONS AND WARNINGS

When using an electrical appliance, basic precautions should always be followed including the following:

### READ ALL INSTRUCTIONS BEFORE USING THE MACHINE

**CAUTION: The operator of this instrument is advised that if the equipment is used in a manner not specified in this manual, the protection provided by the equipment may be impaired.**

### WARNINGS

The manufacturer cannot be held responsible for damage caused when the appliance is not used according to the instructions, or for uses other than those for which it was intended.

This special commercial machine is suitable for the applications mentioned in the operating instructions. Do not use for purposes other than those for which it was designed, as these may be dangerous. The manufacturer cannot be held responsible for damage caused by improper use.

Do not allow children or unauthorised personnel access to the machine or its controls.

The process needs to be checked and documented by authorised persons regularly. See EN ISO 15883-1, -3, and IEC 61010-2-40.

The cycles must not be interrupted, as it would cause danger and affect the cleaning and disinfection result. If interruption occurs, do not make an attempt to open either door and start the process again. In case the fault condition occurs repeatedly, please call for service. In cases of emergency e.g. fire or flooding, cut off the services to the machine using the safety controls provided externally to the unit. The machine is completely isolated from the electricity supply only when it is unplugged or the circuit breaker is turned off. This must be done before any repair work is carried out.

The machine is constructed in accordance with current safety requirements. Any repairs shall only be carried out by an authorised and a suitably qualified and competent engineer.

The electrical safety of this machine can only be guaranteed if connected to an electrical system complying with all relevant regulations and checked by the regulating authority. The manufacturer cannot be held responsible for damage caused by incorrect wiring.

The machine shall only be installed by a suitably qualified and competent contractor. Before connecting the machine, the Installer shall check that the voltage and frequency of the electrical supply correspond with the details on the data plate of the machine.

Only genuine Franke parts or accessories shall be used with the Deko 190 Washer Disinfector. The performance and safety of non-genuine parts or accessories cannot be guaranteed, and use of such parts or items may void the machine warranty. If you have specific questions about machine options or accessories, please call your supplier.

The water in this machine must not be used as drinking water.

Only use detergents, which intended to be used in automatic washer-disinfectors. Do not use solvents in your machine, as there may be a danger of explosion.

Take care when handling liquids such as detergents, rinsing or neutralising agents. These may contain acids or alkalis. Follow the instructions and safety procedures on the packaging carefully and wear protective gloves and goggles. Read the Material Safety Data Sheets.

Do not allow any acids or solvents, especially hydrochloric acid and chlorides, into the wash chamber.

Be careful when sorting instruments with sharp pointed ends. If possible, place the pointed end downwards.

Install special inserts in accordance with the instructions provided.

When using the machine be careful not to scald or burn yourself, especially by opening the door. Baskets and inserts must first be allowed to cool down. Any water, which may have collected in incorrectly loaded items, will be very hot and should be emptied into the wash chamber.

Do not touch the inner surfaces of the wash chamber or the heating elements after the end of a program. You could burn yourself.

Do not hose the machine down to clean it.

Do not sit or lean on the open door. This could cause the machine to tip and be damaged.

When disposing of an old machine, make sure the door catch is removed. This will prevent children at play from being accidentally locked in.

Be careful when removing the panels and working inside the machine because of possible burrs and sharp edges. If possible, use safety gloves.

The manufacturer cannot be held responsible for damage caused by failure to heed the warning and safety instructions.

## USED SAFETY SYMBOLS



**Dangerous voltage**

## 2 INTENDED USE OF THE MACHINE

The Deko 190 Washer Disinfector is suitable for automatic cleaning and thermal disinfection of human waste containers intended for re-use such as;

- \* portable sanitary pans;
- \* supports for single-use bedpans;
- \* hospital bowls;
- \* urine bottles;
- \* suction bottles and
- \* products similar to the above and used for similar purposes

Please see EN ISO 15883-1 and EN ISO 15883-3 for fields of application and restrictions of use.

When processed in the washer-disinfector, the medical devices may be intended for immediate use or may be intended to be packed and sterilised. In both cases the efficacy of the cleaning and disinfection is of major importance. In the first case this is for the well being of the patient, in the latter case it is for the safety of the staff who handles the items in the process.

## **RESTRICTIONS IN USE**

A number of medical devices are excluded from processing in a washer-disinfector altogether. Always follow the Medical Device Manufacturer's instructions for reprocessing the particular item. Re-usable medical devices including hazardous chemicals, gases, materials, parts, components and/or constructions, which do not tolerate water treatment, spray washing and/or heat above +55 Celsius degrees, disposable items, textiles & fabrics, wood, paper & pulp products, tissues and dissolving plastics must not be processed in the Deko 190 washer-disinfector.

### **Items suitable for processing in a thermal disinfector**

All products, accessories, and other items to be cleaned and disinfected in the Deko 190 Washer Disinfector should have the following properties:

- heat resistant to a temperature of up to 138 °C
- corrosion resistance in the presence of heat and alkalinity

The high heat retention capacity of stainless steel allows for fast drying. Plastics and rubber have a lower heat retention capacity, thus needing a longer drying time after processing.

Aluminium discolours. Aluminium only has a limited suitability for processing in this machine.

Carbon steel may corrode in the process.

Rhodium coated specula must be arranged so that their surfaces do not suffer any mechanical damage. Not all specula with glass are suitable for machine treatment.

In case you have any questions regarding the suitability of items for being processed in the Deko 190 Washer Disinfector, please contact its manufacturer for advice.

### 3 STORAGE CONDITIONS

Ambient or room temperature 0 °C - +50 °C  
Relative humidity, non-condensing 10-90 %  
Max. storage time 1 year  
Atmosphere Non-corrosive

### 4 OPERATING CONDITIONS

#### Electrical ratings

See voltage ratings in chapter 6.5 Electrical connection (Maintenance manual)

#### Pollution degree

- pollution degree 2

#### Installation category

- installation category II

#### Maximum relative humidity

80 % for temperatures up to 31 °C

#### Operating temperature range

- 5 °C to 40 °C

#### Maximum altitude

- up to 2000 m

#### Voltage fluctuation limits of the mains supply

-  $\pm 10$  % of the nominal voltage

## 5 OPERATING INSTRUCTIONS

### 5.1 Washing and disinfection cycles

#### 5.1.1 Standard cycles / 190



NORMAL			
Phase	°C	Time	ml
Flush, cold water		~5 s	
Flush, warm water		~5 s	
Circulation wash with detergent		2 min	45
Circulation rinse, hot water		15 s	
Disinfection	90	1 min	
Approximate total time with heating		10 min	



INTENSIVE			
Phase	°C	Time	ml
Flush, cold water		~5 s	
Flush, warm water		~5 s	
Circulation wash with detergent		3 min	45
Circulation rinse, hot water		15 s	
Disinfection	90	1 min	
Approximate total time with heating		11 min	

The following cycle is used for emptying **only**.  
The items must be washed and disinfected before taken into use.



EMPTYING			
Phase	°C	Time	ml
Flush, cold water		~5 s	
Flush, warm water		~5 s	
Approximate total time		1 min	

The following cycle has longer washing time.

LONG			
Phase	°C	Time	ml
Flush, cold water		~5 s	
Flush, warm water		~5 s	
Circulation wash with detergent		5 min	45
Circulation rinse, hot water		15 s	
Disinfection	90	1 min	
Approximate total time with heating		13 min	



### 5.1.2 Standard cycles / 190 (AU,NZ)



NORMAL			
Phase	°C	Time	ml
Flush, cold water		~5 s	
Flush, cold water		~5 s	
Flush, warm water		~5 s	
Circulation wash with detergent		2 min	45
Circulation rinse, hot water		15 s	
Disinfection	90	1 min	
Approximate total time with heating		10 min	



INTENSIVE			
Phase	°C	Time	ml
Flush, cold water		~5 s	
Flush, cold water		~5 s	
Flush, warm water		~5 s	
Circulation wash with detergent		3 min	45
Circulation rinse, hot water		15 s	
Disinfection	90	1 min	
Approximate total time with heating		11 min	

The following cycle is used for emptying **only**.  
The items must be washed and disinfected before taken into use.



EMPTYING			
Phase	°C	Time	ml
Flush, cold water		~5 s	
Flush, warm water		~5 s	
Approximate total time		1 min	

The following cycle has longer washing time.

LONG			
Phase	°C	Time	ml
Flush, cold water		~5 s	
Flush, cold water		~5 s	
Flush, warm water		~5 s	
Circulation wash with detergent		5 min	45
Circulation rinse, hot water		15 s	
Disinfection	90	1 min	
Approximate total time with heating		13 min	

### 5.1.3 Sequence diagrams

Here is a typical curve of DEKO 190 process cycle with main sequences.

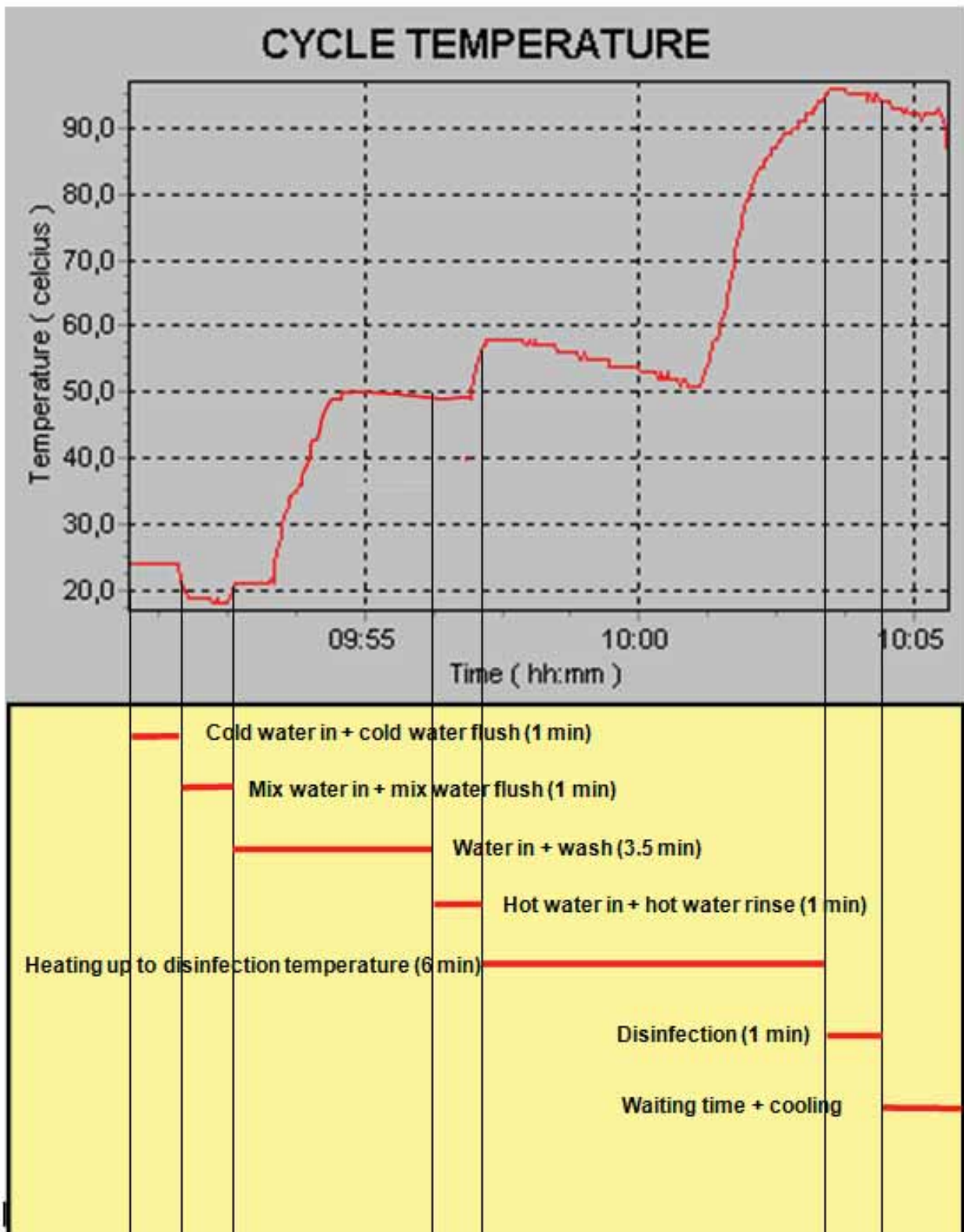

## 5.2 Values of the cycles

Recommended phase values of the cycles.

	Time, sec [ t ]	Temperature, °C [ T ]	Detergent volume, ml [ Q ]	NOTE !
Cold water flush				This is always the first phase
Warm water flush				
Circulation wash	60-1200		0-99	
Hot water rinse	15-300			Must be before disinfection
Disinfection	1-300	75-95		
Wait	It's possible to program a waiting time at the end of the cycle 1-20 min			
<p>- all cycles will start automatically with the cold water flush (container emptying phase)            - warm water flush use both cold and hot water, recommended after cold water flush            - circulation wash includes time and detergent volume parameters            - circulation hot water rinse must be before disinfection, only the rinsing time can be set            - disinfection parameters are time and temperature            - waiting time after the cycle can be used for cooling down the instruments</p> <p><b>Note!</b> The set disinfection time starts when the set temperature has been reached.            Do not use raw water rinsing or washing after disinfection phase.</p> <p>Note ! If the cycle does not include disinfection phase, user will be warned by starting the cycle.</p>				

Read more from chapter 10.0 Programming (Maintenance manual).

## 5.3 Process chemicals

Deko 190 can be equipped with one adjustable dosage pump for detergent.  
 As an option the machine can be equipped with a descaling liquid pump.

Please note that the nature of the item to be processed can require additional actions such as dismantling for separate processing, the pre-cleaning of difficult surfaces (inaccessible sites) by a manual process etc. prior to the item being processed by the machine. Such pre-cleaning can be necessary to reduce the initial bioburden and/or contamination. Please consult the manufacturer of the medical device for processing instructions and note that the cleaning agents and disinfectants used by manual processing must be carefully flushed away with water before the items are loaded into the washer-disinfector. Failure to do so, may cause excessive foaming and/or pressure drop in the water recirculation system decreasing the cleaning efficacy and extending the cycle time.

Depending on the materials of the medical device being processed a variety of different cleaning agents may be used. Generally, detergents shall be liquid, non-foaming, non-abrasive, free rinsing and biodegradable and have the authorities' approvals for their intended use, as required.

For chromium steel alkaline detergents in the pH range 8 -- 14 are preferred. Acid based detergents should only be used for stainless steel items. Medical devices made of aluminium need specific washing agents designed especially for them. Please note that different chemicals may require different process temperatures and times e.g. enzymatic cleaners a temperature between 30 - max 45 degrees Celsius, whereas an alkaline one a temperature between 60 to 90 degrees. The instructions from the manufacturer of the chemical e.g. regarding the concentration and temperature shall be followed. Volume of water in the washing phase is 11 litres.

Please follow the instructions of the manufacturer of the chemical additive for safe handling, data on the biocompatibility (e.g. the maximum permitted residual level on devices). Note that the residual level, which can be tolerated, will depend upon the nature of the chemical and the intended use of the product being cleaned. The specified performance may not be achieved if other process chemicals than those, which have been tested during type testing, or separately with certain process variables, are used.

NOTE ! When using special chemicals, pls find out from the chemical supplier the suitability for chamber material AISI 304 (EN 1.4301, BS 304 S31) and chemical dosing system materials PVC and Silicone.

Chemical hoses are marked with the symbols: Detergent



#### 5.4 Requirements on detergent in Deko washer-disinfectors

1. Use only liquid detergents.
2. The detergent must not foam. Even a small amount of foam will substantially decrease the cleaning effect.

In case there is plenty of foam in the system the machine is unable to clean the goods and the automatic foam removal control will start. The machine will take clean water in and flush the foam into the outlet.

3. The liquid must be free of particles so that the nozzle or the valves of the detergent pump will not get blocked.
4. Normally detergents being used are highly alkaline with a pH-value between 10 and 14.

A strongly alkaline liquid will corrode aluminium and its colouring. Please use special washing agents for aluminium items.

The detergents are powerful and must be handled with care. In case of accidental contact with the skin or clothing wash immediately with clean water. For eyes, seek immediate medical attention.

Tighten the stopper properly in order to prevent accidental spilling. If air tight it could implode container.

5. Recommended dosage is normally 2-5 ml/l.  
The used concentration of detergent is related to
- the degree of water hardness
  - the degree of uncleanness
  - the water temperature

Usually the temperature of washing water should be approx. +60 °C,  
in case of blood somewhat lower.

## 5.5 Process variables

See 5.2.

## 5.6 Required conditions

See also Technical specifications from Chapter 6. and Installation instructions Chapter 7.  
(Maintenance manual)

### Water quality

Deko 190 is designed to operate with potable water (WHO-Guidelines for drinking water quality 1996 refers) supplied directly to it, or with potable water supplied to the water treatment equipment supplying the machine. Water treatment equipment may include e.g. a softener, de-ioniser or reverse osmosis plant, as necessary. Note that many of the attributes of the water supplied to the machine can affect the efficacy and/or efficiency of the process. These include hardness, pH, microbial purity as well as various reactive anions and cations. For testing the water quality please see EN ISO 15883-1 Chapter 6.4.

### Quality of water used in the type tests

For reference, the quality of water used in the process, excluding any final rinse after disinfection, the following values were determined during the microbiological type tests:

Conductivity: 16,4 mS/m

pH: 8,1

Oxidizable substances (Redox potential): UH 482 mV

Total hardness (Salts of Ca<sup>2+</sup>, Mg<sup>2+</sup>, Sr<sup>2+</sup> expressed as mmol CaCO<sub>3</sub>): 0,59 mmol/l

Total dissolved solids (TDS) determined as evaporative residue: 96 mg/l

## 5.7 Controls

### 5.7.1 Operating systems, manual door

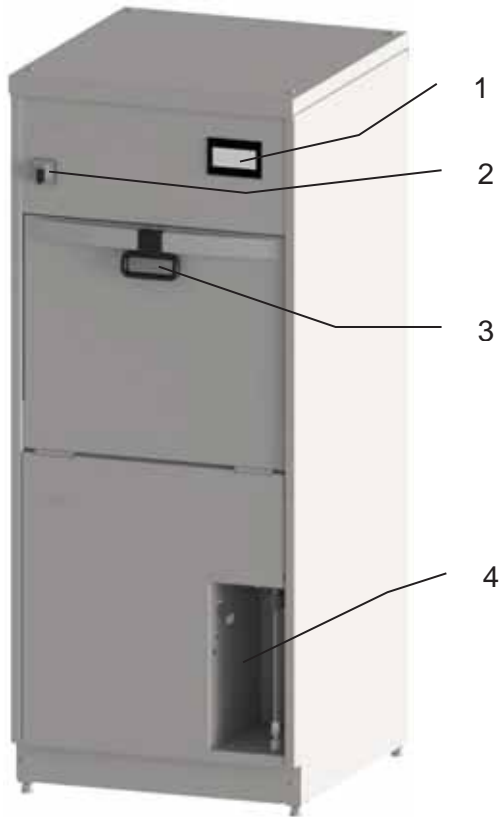

1. Main display and operation keys
2. Main switch
3. Door handle
4. Detergent container (lockable door as option)



Touch screen display for user interface

USER = user mode  
 PROG = programming cycles  
 SERVICE = service mode

				ESC
ABC	DEF	GHI		AC
JKL	MNO	PQRS	→	DEL
TUV	WXYZ		KEY	ENT

				ESC
7	8	9	0	AC
4	5	6	→	DEL
1	2	3	KEY	ENT

Alphanumeric keyboard to enter characters

ESC = Backwards  
 AC = Delete all  
 DEL = Delete a character  
 ENT = ENTER  
 KEY = Switch between numbers and letters

#### Note

The door is interlocked without power

## 5.7.2 Running a cycle







1. Open all water supply taps (cold and hot water) and steam + condensate valves in steam model machine.
2. Switch the machine ON, after ca. 45 sec the following display appears and the machine is ready for use => see 4. RUN mode.



Standard user's run mode page 1.



Standard user's run mode page 2.

-  = to start NORMAL cycle
-  = to start INTENSIVE cycle
-  = to start EMPTYING cycle
- 4 5 6** = to start cycles 4, 5 or 6
-  = to main menu (HOME)
-  = to next display
-  = back to previous display

The next cycle number can be seen on the bottom of the display.

3. By pressing "HOME" key other modes can be selected.



- USER = cycle running mode
- PROG = cycle programming mode (password required)
- SERVICE = service mode (password required)

#### 4. RUN mode

Open the door by turning the door handle upwards and pull the door open.

Load the machine

**Bedpans** are placed in the stationary turning stand in the door as show in fig. 1 when the stand is in upper position. Bedpans are emptied automatically when the door is being closed.

**Bedpan bucket** is placed on the grating turned down from the back wall of the wash chamber; the mouth of the bucket must be to the left (2). Before placing the bucket on the grating it is emptied into the machine. Lid and seating are placed between the supporting rails of the side and back walls.

**Urine bottles** (4 pcs) are pushed over the spray tubes in the door "stomach side" turned upwards (fig. 1, 2, 3 and 4). Urine bottles can be washed together with bedpans, bedpan buckets or wash pans. Urine bottles can not be washed when an instrument basket is being used.

**Wash pans** (4 pcs) are placed into the gaps of the grating turned down (3).

**Other objects** as kidney bowls are washed on the grating; they must be placed upside down on the grating (4).

**Suction bottles** are washed on the special racks (fig.4).

**Small** items are washed in the basket (fig. 5).

#### Note !

Do not pour any liquid or other substances into the chamber which may cause foaming.

#### Hint !

Foaming problems (Faults 11 & 10) can be reduced by adding an extra "cold water flush"-phase.

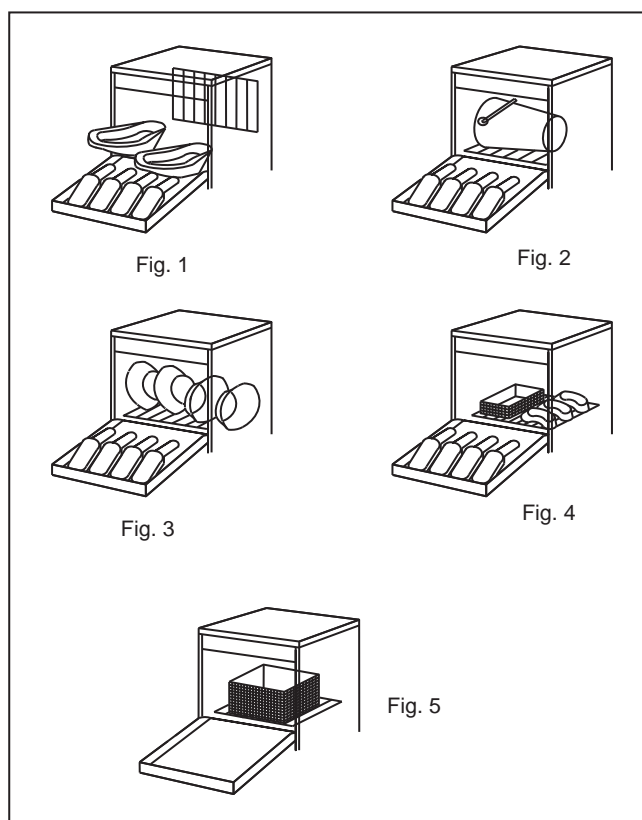

Close the door and lock the door by turning the door handle downwards



## LOADING EXAMPLES AND ACCESSORIES



2 pedpans with lids  
4 urine bottles



Racks for different  
kind of bedpans (\*)



Bedpan bucket  
4 urine bottles



4 hand wash basins  
4 urine bottles



Various items on shelf  
4 urine bottles



Basket for small items  
4 urine bottles



Utensil basket



Shoe rack



Suction bottle rack



Kidney bowl rack



Rack for 4 extra  
urine bottles

(\*) If bedpans do not fit properly to the rack,  
please be in contact with the local distributor

## Start the cycle

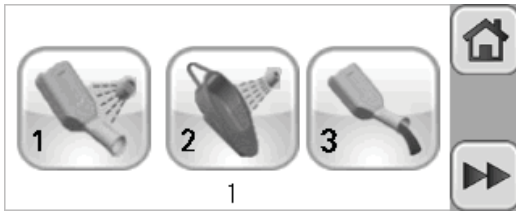

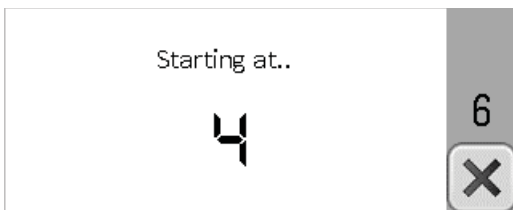
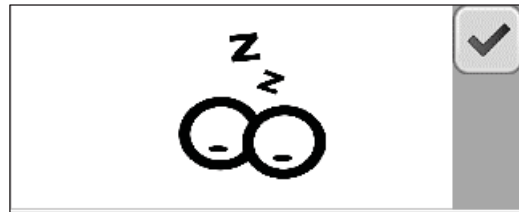

Start the wanted cycle by pressing the start icon key or the number key on next page.

If the machine is unused for a period of ten minutes it will go into standby mode. By pressing “” key this will bring the machine out of standby and open the door interlock.



The selected cycle may be cancelled by pressing  key within 5 sec's.



If the selected cycle does not include disinfection phase (e.g. emptying cycle), a notice will appear on display, this must be accepted by pressing  key or cancelled by  key.

**NOTE !** The cycle will not start if the chamber temperature is too high. Cool the chamber by opening the door.

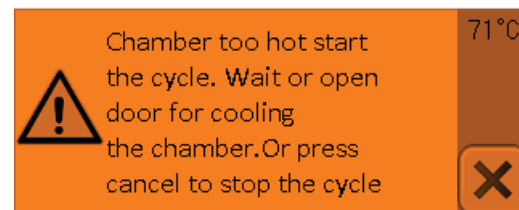

During a cycle the display indicates:

Selected cycle number	"6"
Cycle phase	"CW Flush"
Chamber temperature	"24 °C"
Remaining cycle time	"13 min"

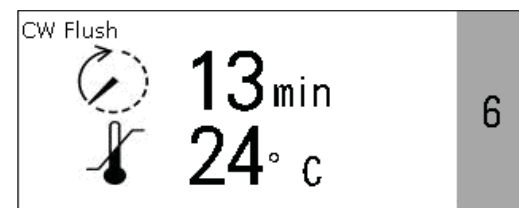

## End of cycle

The end of the cycle will be indicated with an audible buzzer and the text "CYCLE COMPLETED".



Note !  
If the cycle did not include disinfection phase, this will be warned on display.

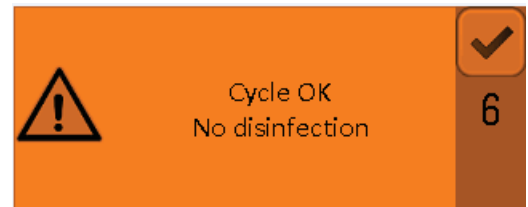

Open the door by turning the door handle upwards and pull the door open.

**Beware of hot steam coming from the chamber after opening the door !**

**Beware of hot items and load carriers after opening the door. It's recommended to allow load items to cool down sufficient time (e.g. 1 min) before unloading !**

**Note ! The door is interlocked without power**

If the machine is unused for a period of ten minutes it will go into standby mode. By pressing " key this will bring the machine out of standby and open the door interlock.

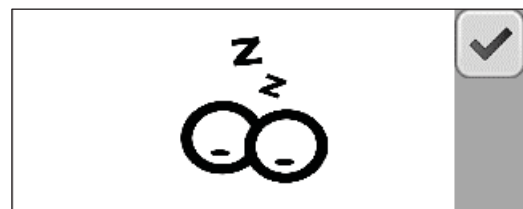

### 5.7.3 Malfunctions

WARNING situations, which can be controlled by the User, are being indicated as shown below. If the recommended actions have been taken, press the  key . After the fifth indication (door open or lack of chemical) the machine will switch over into FAULT condition.

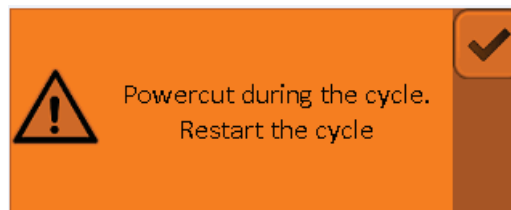
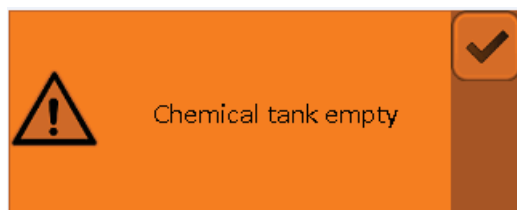

See warnings from the table below:

Warning text	Explanation
Chemical tank empty	Change or re-fill the detergent container.
Close door	The loading door is open or not closed correctly
Chamber too hot for starting the cycle. Wait or open the door for cooling the chamber. Or press cancel to stop the cycle.	A new cycle will not start if the chamber temperature is over 60 °C
No disinfection	Must be confirmed by the user if the cycle does not include disinfection phase.
Cycle OK, No disinfection	Must be confirmed by the user if the cycle does not include disinfection phase.
Open water valves	Water valves shall be open when starting.
Power cut during the cycle	There has been a power cut and the ongoing cycle must be restarted
Parameters are not OK	Contact service / Deko distributor

#### Banner warnings:

Banner warnings appear as scrolling text at the top of the user screens and in the warning log of service display.

See maintenance manual APPENDIX 1.

## INCOMPLETE OPERATING CYCLE

Fault display appears if the asked actions have not been taken or some detector/component is broken.

Service shall always be contacted and called for, if a fault condition occurs.

In a Fault condition an ERROR code will be displayed identifying a possible cause of the fault.

See the list of malfunctions, APPENDIX I.



Actions in Fault case are described in maintenance manual "9.3 Fault log"

**After an incomplete operating cycle all items in washing chamber must be washed and disinfected again !**

## 5.8 Purging and disinfecting the WD

All parts of the machine supplying fluids to the load or chamber are purged and disinfected during a normal operating cycle. The wash chamber and pipework of the machine have been designed so that any remaining process water shall flow towards the discharge point of the machine.

Should the machine not have been used for a period longer than 24 hours, it is recommended that a short cycle including disinfection be run before placing a load into the machine for processing. However, all the cycles validated and sealed by the manufacturer include a disinfection phase as the last phase of the process. **Service engineers shall pay attention to the state of the machine before dismantling any parts of the chamber or pipework. Unless informed otherwise, it shall always be assumed that there may be harmful microorganisms present by a Fault condition or water system breakdown.**

## 5.9 Methods of cleaning

Daily:

Check that all the sprayers rotate freely and the spray holes are open  
In case the fixed or rotating nozzles get blocked the cleaning effect will deteriorate.  
Please take care of keeping the nozzles clear

Weekly:

Use a toilet brush and clean the outlet sieve by brushing it a few times



Clean the outer stainless steel panels with diluted washing agent and soft washcloth; flush, wipe and dry. See also chapter 11.3 (Maintenance manual)

Chamber cleaning: see section 9.7 (Maintenance manual)

## 5.10 Flushing of chemical dosing systems

To avoid problems in chemical dosing like solidified detergent and blocked piping it's very important to flush the system regularly with hot water.

It's recommended to flush the dosing systems every two weeks and always whenever the detergent container is changed.

Fill a container with hot tap water and put the detergent suction tubes into the container.  
In user's mode press -key to find "Chemical dosing flush"-key . By pressing it the chemical dosing system can be flushed. Repeat the flushing 3 times.

**Put the suction tubes into the detergent container and turn on the pumps once again to refill the system with the current detergent.**



## 6 TESTING

Tests for operational, performance and routine testing are described in standard **EN ISO 15883-1**, Washer-disinfectors Part 1: General requirements, definitions and tests; Chapter 6 Testing for conformity and in the Informative Annex D.

See also **EN ISO 15883-3**, Washer-disinfectors-Part 3: Requirements and Tests for Washer-disinfectors employing thermal disinfection for human waste containers

They may be used in type tests, work tests, and in validation and re-validation tests, or in periodic routine tests carried out by the user.

## 7 RECYCLING AND DISPOSAL INSTRUCTIONS

Packing materials are recyclable and shall be disposed of in accordance with local regulations.

Electronic control cards and components shall be removed and delivered to respective collection places.

Machine framework and other metal parts can be recycled and delivered to metal collection places.

Please follow the instructions and regulations of the local authorities by the disposal of a used machine.

Chemicals (e.g. detergents) shall be disposed of according to the instruction of the chemical's supplier.

### **Note !**

By disassembly of machine pls beware of using protective wear eg. gloves, respirator.

## 8 DECLARATION OF CONFORMITY

Manufacturer: FRANKE MEDICAL OY

Address: Vartiokuja 1, 76850 Naarajärvi, FINLAND

Hereby declares that: Deko 190 complies with the following Directives:

- Medical Device Directive (93/42/EEC)
- The Restriction of Hazardous Substances Directive (RoHS 2011/65/EU)

and that the following harmonized standards have been applied:

- EN 61010-1 Safety requirements for electrical equipment for measurement, control, and laboratory use  
General requirements
- IEC 61010-2-040 Particular requirements for washer disinfectors used in medical, pharmaceutical, veterinary and laboratory fields.
- EN 61326-1 Electrical equipment for measurement, control and laboratory use.  
EMC requirements.
- EN ISO 13485 Medical devices. Quality management systems. Requirements for regulatory purposes (ISO 13485:2016)
- EN ISO 15883-1 Washer-disinfectors, Part1: General requirements, definitions and tests
- EN ISO 15883-3 Washer-disinfectors, Part3: Requirements and tests for washer-disinfectors employing thermal disinfection for human waste containers.



This product complies with the essential requirements of the applicable European laws and Directives with respect to safety, health, environment and consumer protection. Design, manufacture and final inspection in Franke Medical Oy are evaluated by **Eurofins Expert Services Oy** which Notified Body is no. 0537 under the Council Directive 93/42/EEC.

(Signature)  
Antero Asikainen, Managing Director



## 9 WARRANTY TERMS AND CONDITIONS

Dear Deko Customer,

Rhima Australia warrants the Deko Washer Disinfectors to be free from defects in material and workmanship under "normal use and service", which does not include normal wear and tear or preventative maintenance service. Specifically not covered by warranty are service calls to adjust thermostats, detergent dispensers, user errors, racks and accessories, commissioning or any other service requirement not strictly related to defects in material or workmanship.

Rhima Australia will repair or replace any parts, **which in Rhima Australia's sole judgment**, are defective in material and/or workmanship. No responsibility will be accepted for repairs, defects or damages due to improper installation, misuse or neglect. The Deko machines are manufactured with great care; prior to delivery they must pass an extensive quality control. If your machine shows any material or manufacturing defect, you will have a legitimate claim.

The following conditions apply and if in doubt, please refer to our general terms and conditions:

1. Within the warranty period we shall repair any faults with your Deko machine, free of charge, if caused by a material or manufacturing defect. Replaced defective parts will be returned to us and become our property. Warranty is 12 months on parts. In state capitals (within a 50 km radius of GPO) a 3-month warranty on labour, to replace defective parts, applies. All other areas are not covered by a labour warranty, unless specifically mentioned in writing. In any case, **warranty repairs are only carried out within normal business hours** (Monday to Friday, 08.00-17.00 hrs, excluding public holidays).
2. The warranty period starts on the commissioning date. The commissioning must be undertaken within 1 month of machine delivery or warranty will commence from the delivery date.
3. A warranty claim is not valid for defects caused by tampering or repair work carried out by unauthorized persons. This also applies to the fitting of additional accessories, which were not designed for our machines.
4. If a machine, which has been repaired within the warranty period, develops the same fault within 3 months after the repair, the fault will be repaired free of charge, if the cause for this defect is inexperienced repair work, or a material or manufacturing defect of the replaced spare parts, or of the replaced machine. Otherwise the warranty period will not be extended by warranty work.
5. Additional or different claims, especially those for damages caused outside the machine are invalid, unless a liability is enforced by law.
6. All warranty call outs must be approved by Rhima and have an order number.
7. The following is expressly excluded from warranty claims:
  - service or parts relating to blockages due to misuse
  - defects to racks and accessories
  - service or parts relating to inlet and outlet hoses
  - adjustments to temperatures, (water)levels, detergents etc
  - incorrect use or incorrect installation
  - any breakdown due to external influences (high or low water temperature /pressure/ quality, interruption of electricity supply etc)
8. If you call, please have the following information ready:
  - date of purchase ( see invoice/receipt)
  - type of defect / description
  - Machine serial number \*

For full information on warranty conditions, please refer to our general terms and conditions, which are available on request.

**\* EACH MACHINE HAS A SERIAL NUMBER. WARRANTY CLAIMS WITHOUT THIS NUMBER WILL NOT BE TAKEN INTO CONSIDERATION. THIS NUMBER IS LOCATED INSIDE THE DETERGENT DOOR ON THE LEFT SIDE PANEL.**



## List of malfunctions:

Code	Explanation	Actions
1	Door opened during the cycle	Check and adjust micro switch of the door and function of the interlock.
2	Open circuit in controlling temperature sensor T1	Check the sensor and connections. If necessary, change the sensor.
3	Short circuit in controlling temperature sensor T1	Check the sensor and connections. If necessary, change the sensor.
4	Open circuit in verifying temperature sensor T2	Check the sensor and connections. If necessary, change the sensor.
5	Short circuit in verifying temperature sensor T2	Check the sensor and connections. If necessary, change the sensor.
6	Disinfection temperature over set value	Temperature 15 °C over set value. Check heating coils and contactor; steam pressure and steam valve in steam heated machines
7	Not in use	
8	The machine does not get water	Check water supply solenoid valves, mud filter and water level switch in tank, air valves must be open.
9	Water level switch of the tank does not change position or circulation water pump does not work. There is water in tank wrong time.	Check water level switch and pump. Check function of air valves. Drain blocked ? Leakage of water valves ?
10	Fault in heating, the set temperature has not been reached within 20 min.	Check heating contactor, coils and overheating protector. There is water in chamber bottom (water trap) => check the function of siphon valve. Air valve(s) are not open. foam in steam generator.
11	Low circulation water pressure	Check circulation pump and it's running direction . Foaming ? Check pressure sensor. Air valves and siphon valve must be closed during recirculation wash. Chamber outlet or drain sieve blocked ? Check function of tank valve (part 2.40); only in open air gap models.
12	Temperature difference between sensors T1 and T2 is over 2 °C	Calibrate the temperature sensors T1 and T2
13	Water tank is not empty	Check pump is running. Check function of water level switch. Drain blocked ?
14	Door is not interlocked	Check the function of interlock and micro-switch
15	Not in use	
16	Not in use	
17	Not in use	
18	Thermal relay of circulation water pump tripped	Check the reason for pump's overload (obstacles inside piping ?) Reset the thermal relay.
19	Door interlock opened during the cycle	Check and adjust micro switch of the door lock.
20	Temperature has dropped under the set value	During disinfection the temperature has dropped under the set value. Check: heating coils, contactor and overheating protector. Foam or scale in steam generator?
21	Not in use	
22	Temperature difference between sensors T1 and T2 is over 10 °C	By starting the machine the temperature difference between sensors is over 10 °C, calibrate temperature sensors T1 and T2.
23	Chemical container empty	Fill/change the container, check detector
24	Door is not closed in the beginning of the cycle	Check door micro switch and door functions



**List of banner warnings:**

Banner warnings appear as scrolling text at the top of the user screens and in the warning log of service display.

Code	Warning	Explanation
W100	PLC / HMI program version mismatch	Version numbers of PLC and HMI softwares must be same. See first page in service mode.
W101	Parameters not OK. Check parameters	e.g. when replacing PLC the parameters must be set.
W102	Periodical service required. Contact local service	The set service counter value has been achieved.
W103	Temperature calibration 50 °C not done	Calibrated value at 50 °C is missing.
W104	Temperature calibration 90 °C not done	Calibrated value at 90 °C is missing.
W105	Detergent calibration not done	Calibrated value is missing.
W300	SD memory card not in place or write protected	Files from SD memory card can't be read or write
W301	SD memory card full	Less than 1 kbyte space on SD memory card
W302	Parameters not loaded from SD	Fault when reading a file from SD memory card.
W303	Cycle recipes not loaded from SD	Fault when reading a file from SD memory card.
W304	Calibration values not loaded from SD	Fault when reading a file from SD memory card.
W305	Cycle report save to SD failed	Fault when saving data to SD memory card.
W900	PLC not at run	Logic module in not in RUN mode
W901	PLC error	Fault in logic module.
W902	HMI error	Fault in display.
W903	Comm error	Communication between PLC and HMI does not work.
W904	PLC program missing	The application software is missing in logic module.



# USER INSTRUCTIONS





## REPLACEMENT OF DETERGENT CONTAINER



1. Take out the detergent container.



2. Remove the suction pipe from the container.  
3. Replace the container.



4. When necessary adjust the length of the suction pipe

5. For controlling the consumption of detergent, it is recommended to mark with date the level



**When you handle process chemicals - wear protection gloves and follow the suppliers' safety instructions.**

## CLEANING OF SPRAY WASHERS & NOZZLES

**CHECK THAT SIDE WASHER ROTATES FREELY**

- the washer can be removed by opening the screw on top
- without tool



**CHECK THAT BOTTOM WASHER ROTATES FREELY**

- the washers can be removed by opening the screw on the top part of the washers
- without tool



**CHECK THE URINE BOTTLE NOZZLES ARE FREE OF DIRTY**  
- for removing e.g. adjustable wrench







Deko 190X pictured

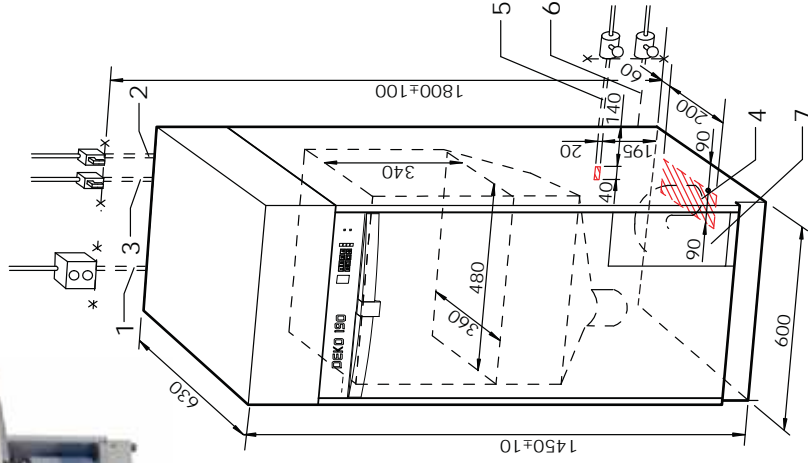

Dimensions pictured

**Placement:** A minimum clearance of 20mm either side of the machine is recommended.

**Maintenance:** If possible for cleaning and maintenance a 200-300mm clearance either side is preferred.

## TECHNICAL SPECIFICATIONS

### 1. ELECTRICITY

240/415V AC, 3-phase + Neutral, 20Amp

**Please note:**

Plug NOT included - Must be connected using a disconnect device. A plug MAY be fitted to the machine at an extra cost. At the time of the installation check the motor direction. (International wiring rules apply)



### 2. COLD WATER

Flexible inlet hose with R $\frac{1}{2}$ " female thread,  
L = 2 m (Min 5°C - Max 25°C)  
Water flow rate: Min 100kPa - Max 600kPa



### 3. HOT WATER

Flexible inlet hose with R $\frac{1}{2}$ " female thread,  
L = 2 m (Min 65°C - Max 80°C)  
Water flow rate: Min 100kPa - Max 600kPa



### 4. WASTE OUTLET

Ø110 mm (hatched area for centre of the pipe)  
Drain flow rate 2ltr / Sec. "S" or "P" trap inside machine. Max discharge temp 65°C.

### 5. STEAM - For steam heated model ONLY

Steam, flexible steel armoured inlet hose with R $\frac{1}{2}$ " male thread, L = 1,2 m

### 6. CONDENSATE - For steam heated model ONLY

Flexible steel armoured inlet hose with R $\frac{1}{2}$ " male thread, L = 1,2 m.

### 7. SUCTION HOSE and place for detergent.

Wall anchors will be supplied & must be installed by purchaser. **ONLY ROOM VENTILATION REQUIRED.**

## Floor and wall installation of the drain.

Detail A

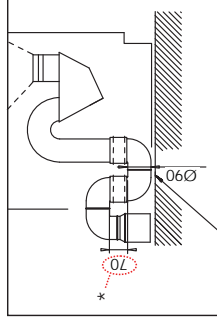

Detail B

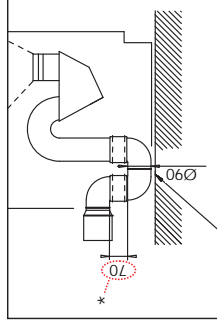

**Note:** There must be a space of 5mm between the plastic water trap and the floor.

**S - Trap**  
(Floor connection)

**P - Trap**  
(Wall connection)

\*Please note: Failure to set this distance correctly can cause unit to malfunction.



A typical drain connection pictured (above)



**WATERMARK LICENSE WM-022073**  
ATS 5200.104

This appliance incorporates back flow prevention complying with AS 3500.1. No further back flow protection is required for connection to the water supply.



Quality  
ISO 9001



**WaterMark**  
ATS5200.104  
WM-022073



**Rhima Australia Pty Ltd**

ABN 63 007 242 604

72-74 Woodlands Drive Braeside 3195

PO Box 605 Braeside Vic 3195

Tel: 1300 347 944 or 03 8586 5444

Fax: 03 8586 5454

[www.rhima.com.au](http://www.rhima.com.au)